

Surface Mount Schottky Barrier Rectifier

Features

- Metal silicon junction, majority carrier conduction
- For surface mounted applications
- Low power loss, high efficiency
- High forward surge current capability
- For use in low voltage, high frequency inverters, free wheeling, and polarity protection applications
- Marking: SSL34

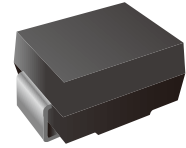

Functional Diagram

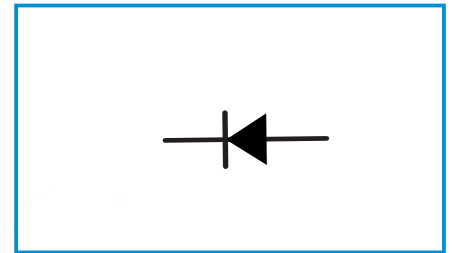

Mechanical Data

- Case: SMB
- Terminals: Solderable per MIL-STD-750, Method 2026
- Approx. Weight: 95mg (0.0034oz)
- Polarity: Cathode line denotes the Cathode end

Maximum Ratings and Electrical Characteristics

Ratings at 25°C ambient temperature unless otherwise specified.
 Single phase half-wave 60Hz, resistive or inductive load, for capacitive load current derate by 20%.

Parameter	Symbols	LT3B40	Units
Maximum Repetitive Peak Reverse Voltage	V_{RRM}	40	V
Maximum RMS voltage	V_{RMS}	28	V
Maximum DC Blocking Voltage	V_{DC}	40	V
Maximum Average Forward Rectified Current at $T_c = 100\text{ }^\circ\text{C}$	$I_{F(AV)}$	3	A
Peak Forward Surge Current 8.3 ms Single Half Sine Wave Superimposed on Rated Load	I_{FSM}	80	A
Maximum Instantaneous Forward Voltage at 3 A	V_F	0.45	V
Maximum DC Reverse Current at Rated DC Blocking Voltage $T_a = 25\text{ }^\circ\text{C}$ $T_a = 100\text{ }^\circ\text{C}$	I_R	0.3 5	mA
Typical Junction Capacitance ⁽¹⁾	C_j	450	pF
Typical Thermal Resistance ⁽²⁾	$R_{\theta JA}$	60	$^\circ\text{C/W}$
Operating Junction Temperature Range	T_j	-55 ~ +150	$^\circ\text{C}$
Storage Temperature Range	T_{stg}	-55 ~ +150	$^\circ\text{C}$

(1) Measured at 1 MHz and applied reverse voltage of 4 V D.C

(2) P.C.B. mounted with 2.0" X 2.0" (5 X 5 cm) copper pad areas.

Ratings and characteristics Curves

Fig.1 Forward Current Derating Curve

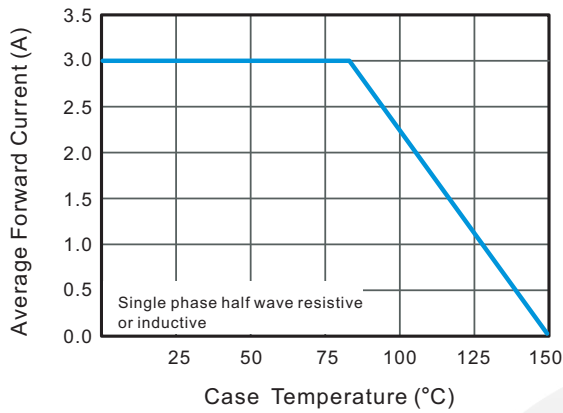

Fig.2 Typical Reverse Characteristics

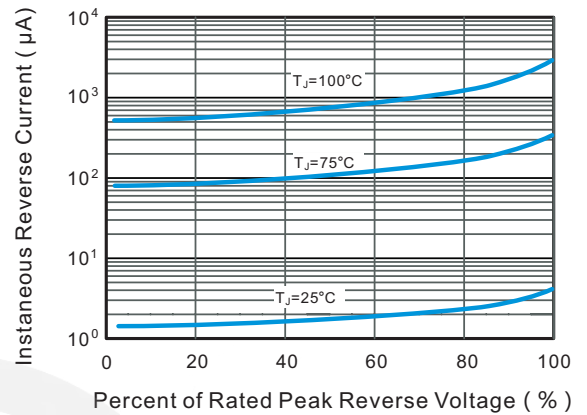

Fig.3 Typical Forward Characteristic

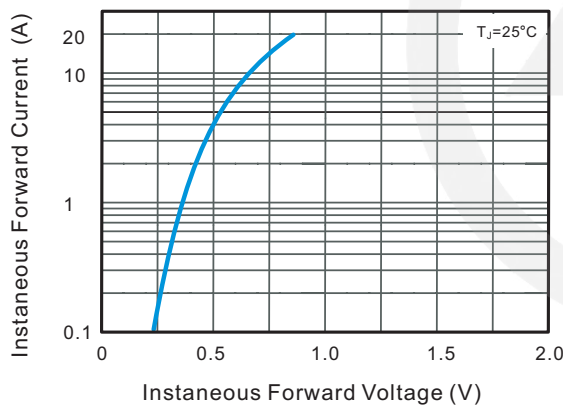

Fig.4 Typical Junction Capacitance

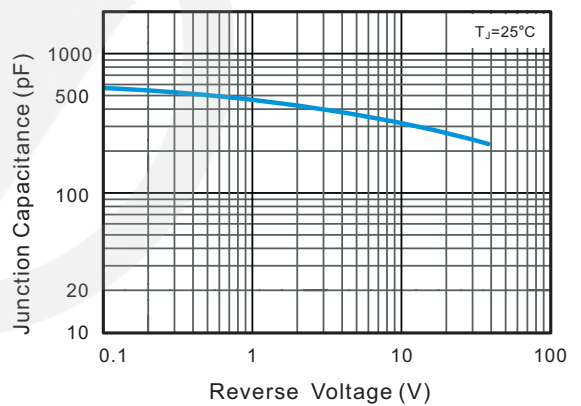

Fig.5 Maximum Non-Repetitive Peak Forward Surge Current

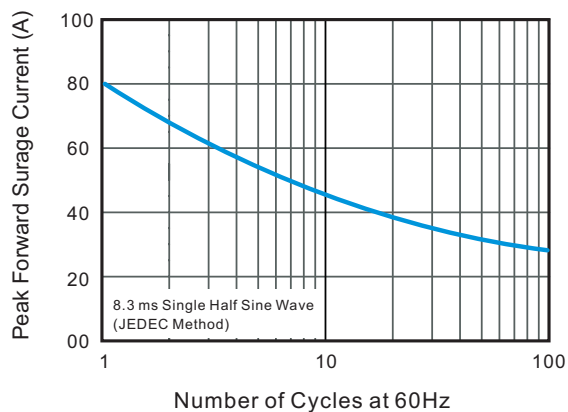
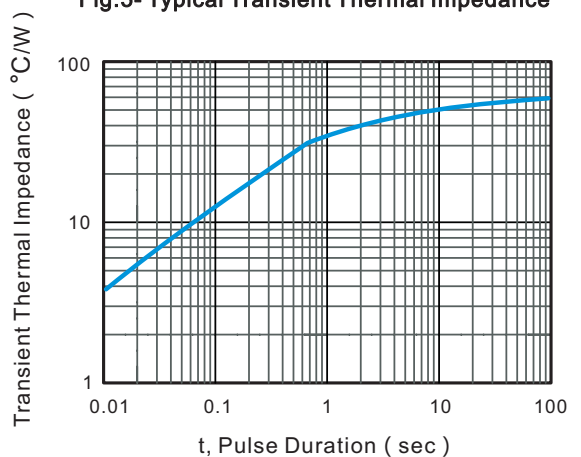
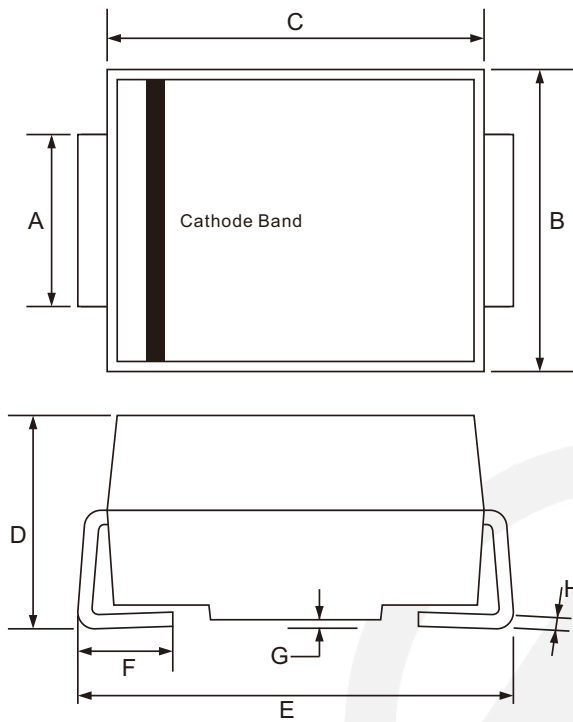

Fig.5- Typical Transient Thermal Impedance



SMB Package Outline



Unit: mm

SYMBOL	DIMENSIONS	
	MIN.	MAX.
A	1.900	2.200
B	3.300	3.940
C	4.060	4.700
D	2.130	2.440
E	5.080	5.590
F	0.800	1.500
G	0.050	0.200
H	0.152	0.305

SMB Suggested Pad Layout

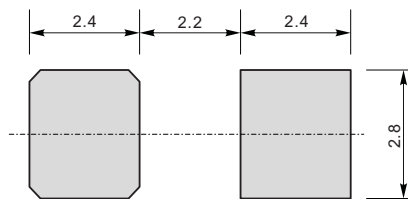

Unit: mm

Note:

1. Controlling dimension: in millimeters.
2. General tolerance: $\pm 0.05\text{mm}$
3. The pad layout is for reference purpose only.

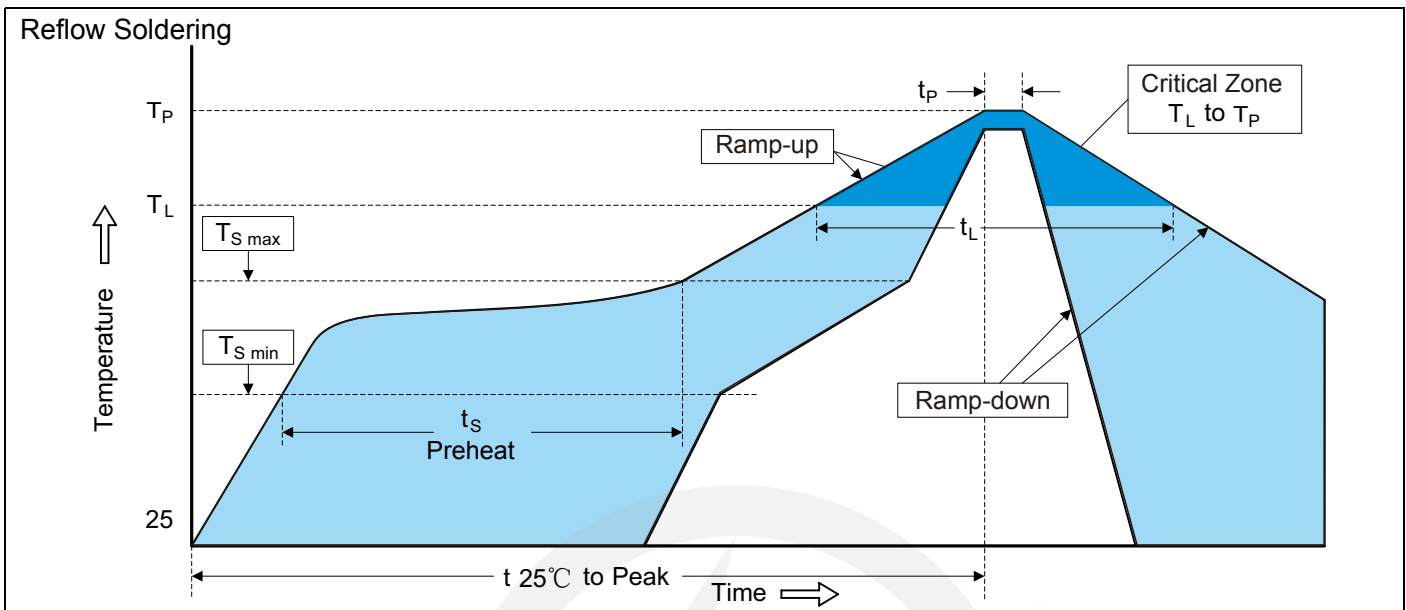
Recommended Soldering Conditions

Recommended Conditions

Profile Feature	Pb-Free Assembly
Average ramp-up rate (T _L to T _P)	3°C/second max.
Preheat -Temperature Min (T _{S min}) -Temperature Max (T _{S max}) -Time (min to max) (t _s)	150°C 200°C 60-180 seconds
T _{S max} to T _L -Ramp-up Rate	3°C/second max.
Time maintained above: -Temperature (T _L) -Time (t _L)	217°C 60-150 seconds
Peak Temperature (T _P)	260°C
Time within 5°C of actual Peak Temperature (t _P)	20-40 seconds
Ramp-down Rate	6°C/second max.
Time 25°C to Peak Temperature	8 minutes max.

Packaging

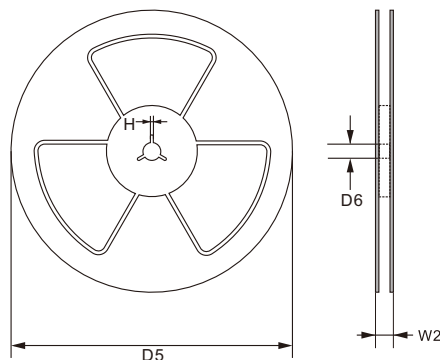
13" Reel



D5 Φ330.0±2.0

D6 Φ13.5±0.5

H 2.5±1.0

W2 16.0±2.0

Quantity: 3000PCS